

K1

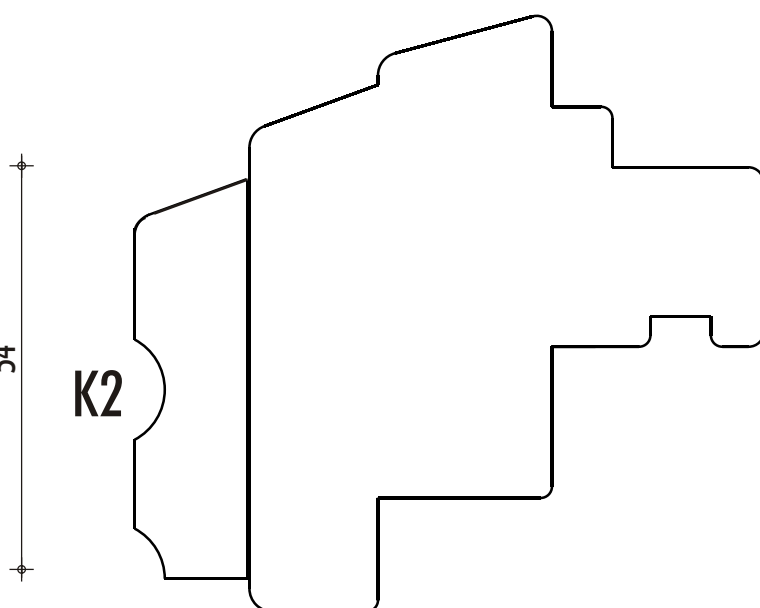

K2

Typ VB

Berliner
Fenster

Kämpferprofile

grundsätzlich
bis Außenkante
Blendrahmen
Verleimung nur auf
dem Kämpfer

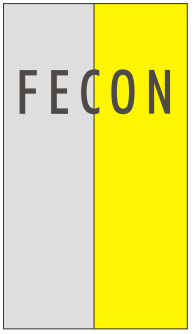

K 3 (KP - 04)

55

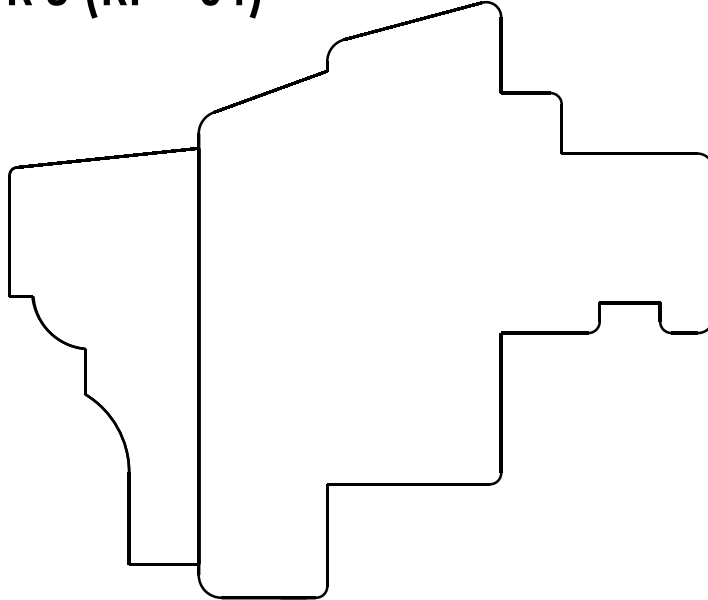

Typ VB

Berliner
Fenster

Kämpferprofile

K 4 (KP - 01)

55

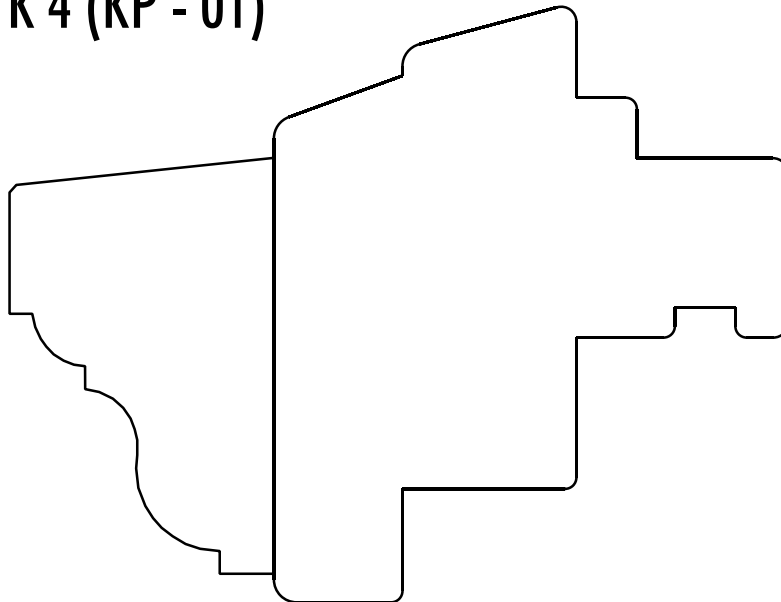

grundsätzlich
bis Außenkante
Blendrahmen
Verleimung nur auf
dem Kämpfer



K5 (KP - lt. Dehnkatalog)

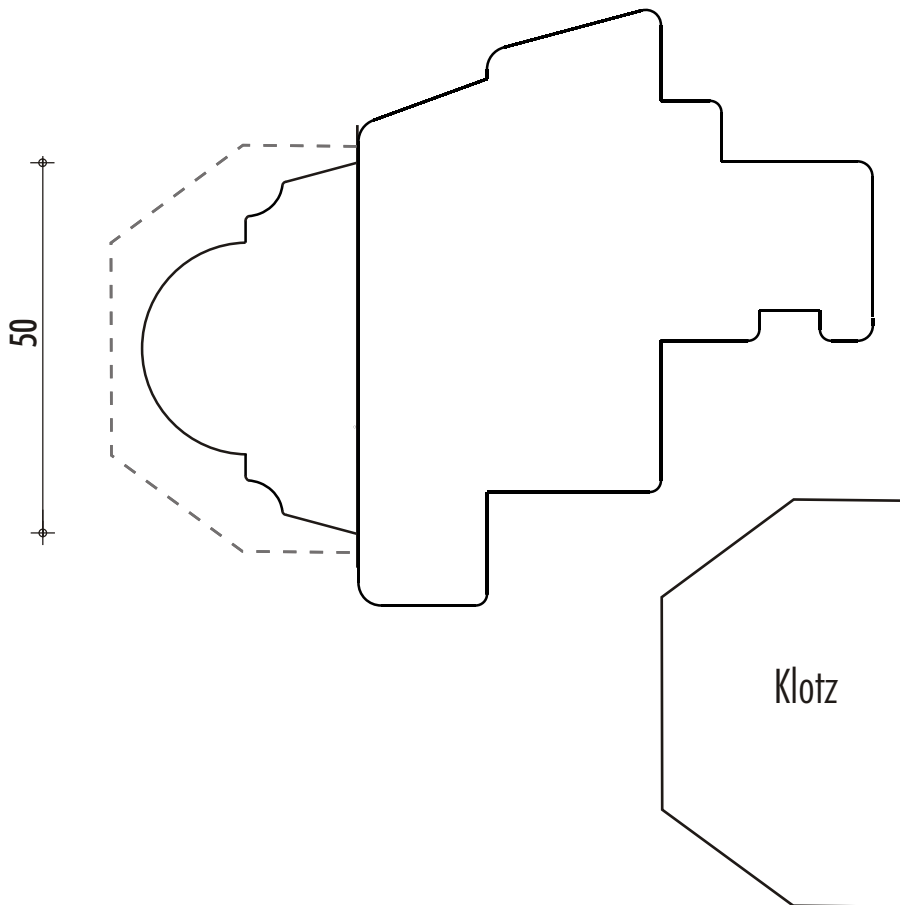

Typ VB

Berliner
Fenster

Kämpferprofile

grundsätzlich
bis Außenkante
Blendrahmen
Verleimung nur auf
dem Kämpfer

S 5 (SL -28)

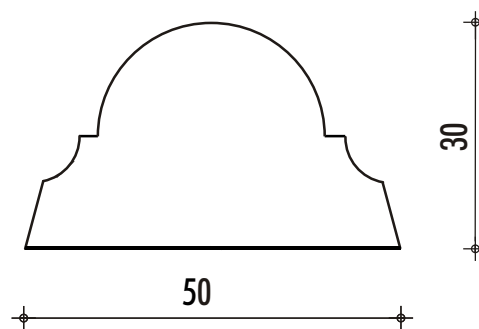

Profilierte
Schlagleiste



S 1 (SL - 07)

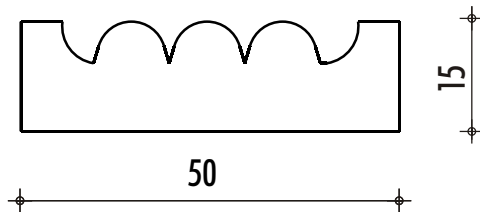

S 2 (SL - 05)

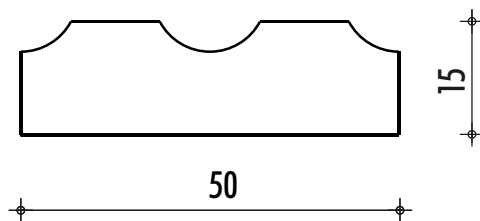

S 3 (SL - 17) - ich bitte um DKF - Datei

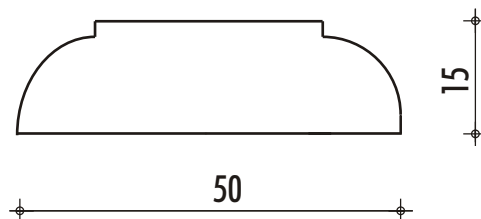

S 4 (SL - 11)

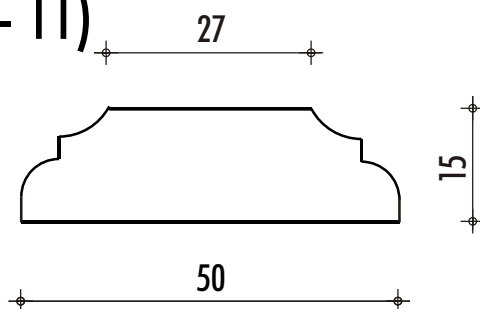

S 6 (SL - 14)

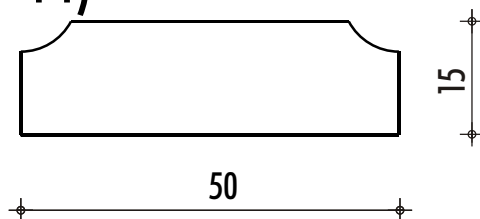

Typ VB

Berliner
Fenster

Profilierte
Schlagleisten

W 1

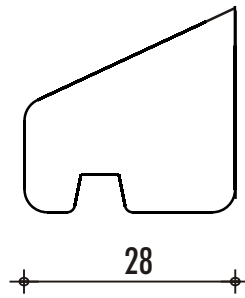

W 2

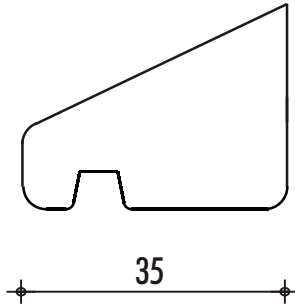

W 3

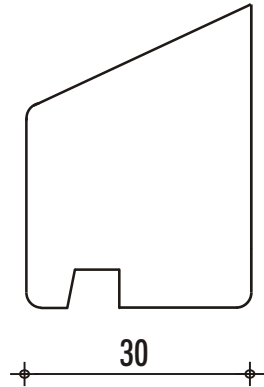

W 4

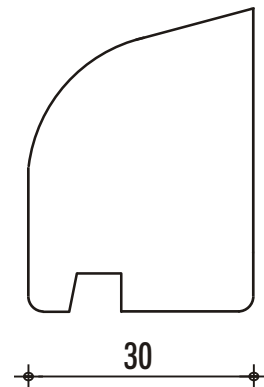

W 5

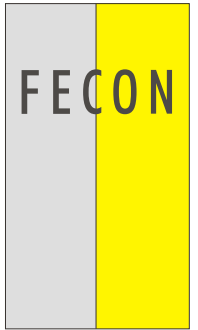
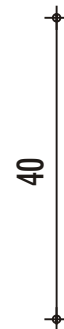
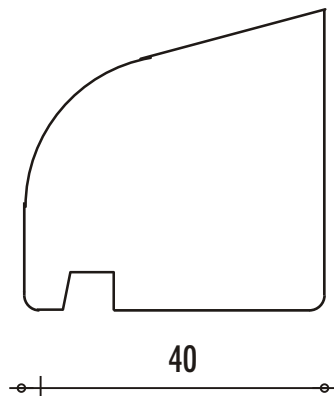

Typ VB

Berliner
Fenster

Wetter-
schenkel

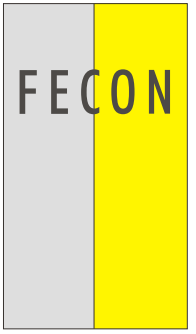

Deckleiste

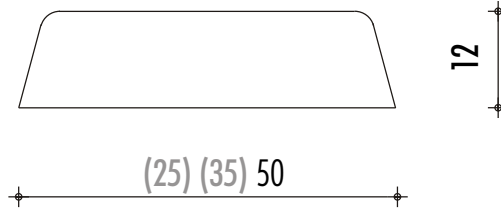

Typ VB

Berliner
Fenster

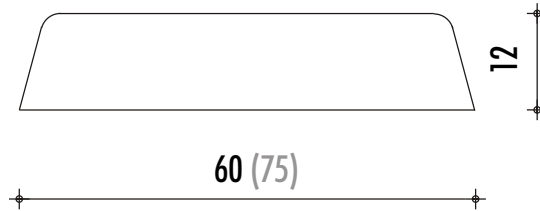

Deck- und Putz-
leisten

werden in
Längen von
3,00 m geliefert

Putzleiste

